

MD 365 B L16

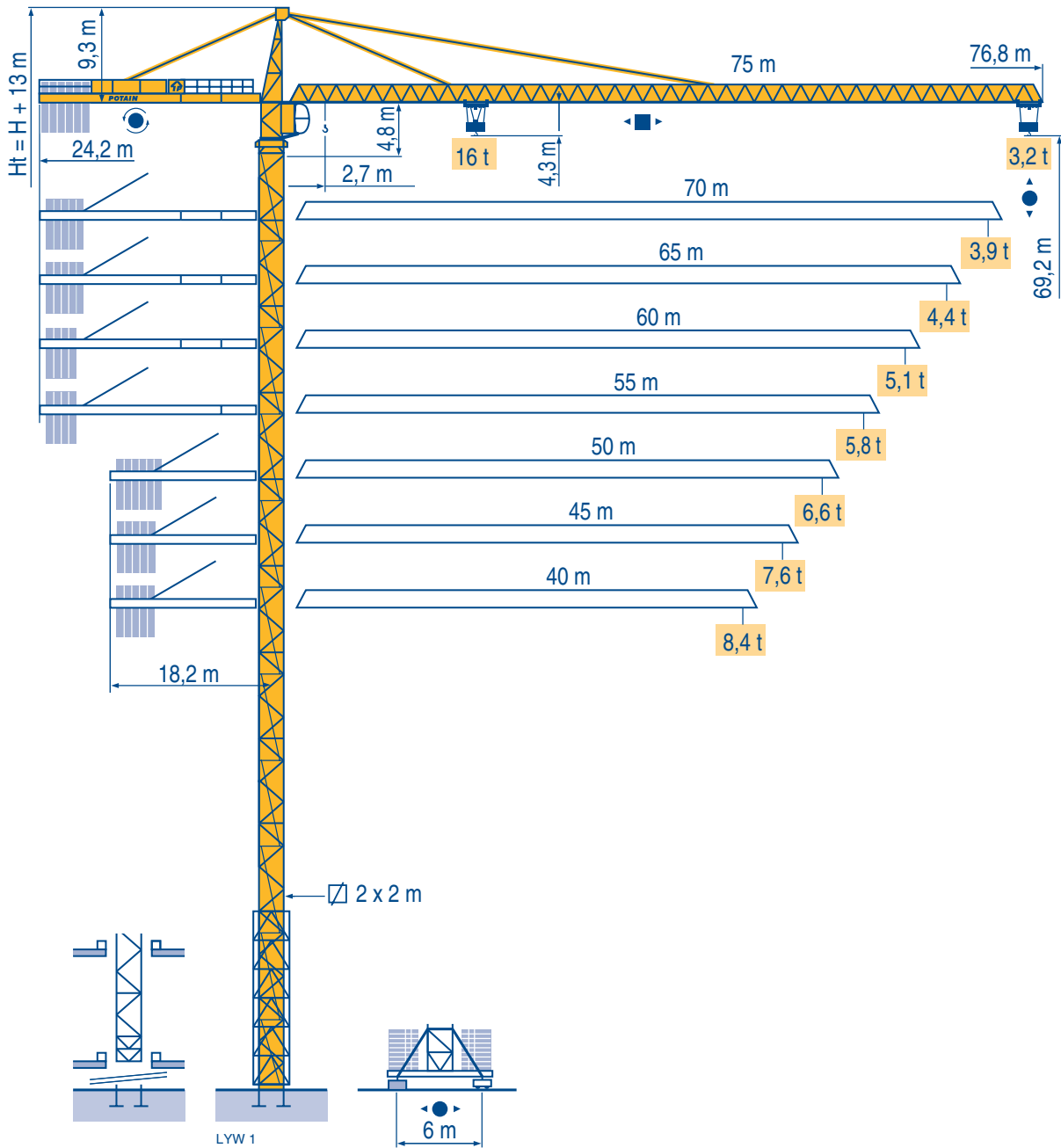

Mat / Réactions \square 2 m
 Maste / Eckdrücke \triangle 40 m \Rightarrow 75 m
 Masts / Reactions
 Mástil / Reacciones
 Torre / Reazioni
 Tramo / Reações

LYW 1

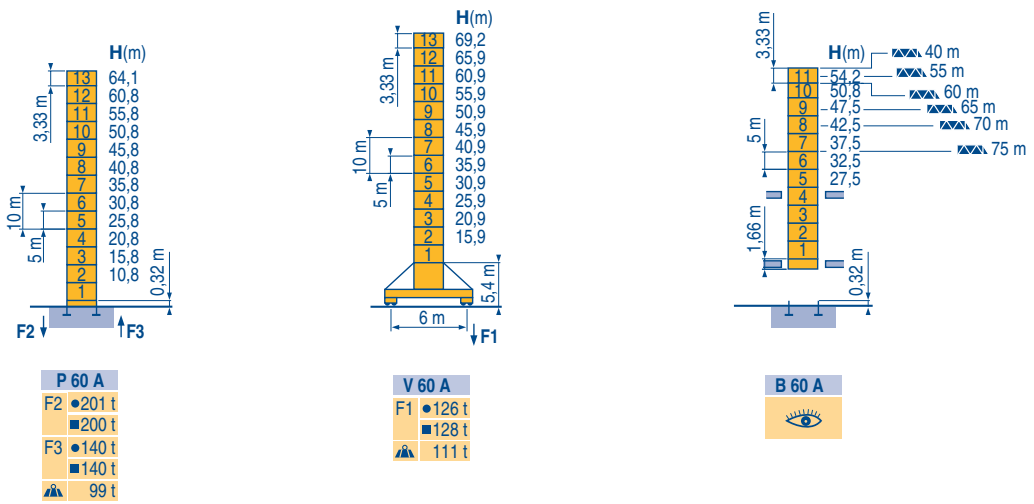

Télescopage sur dalles
 Kletterkrane im Gebäude
 Climbing crane
 Telescopage gruas trepadoras
 Gru in cavedio
 Telescopagem sobre lajes

LYW 1

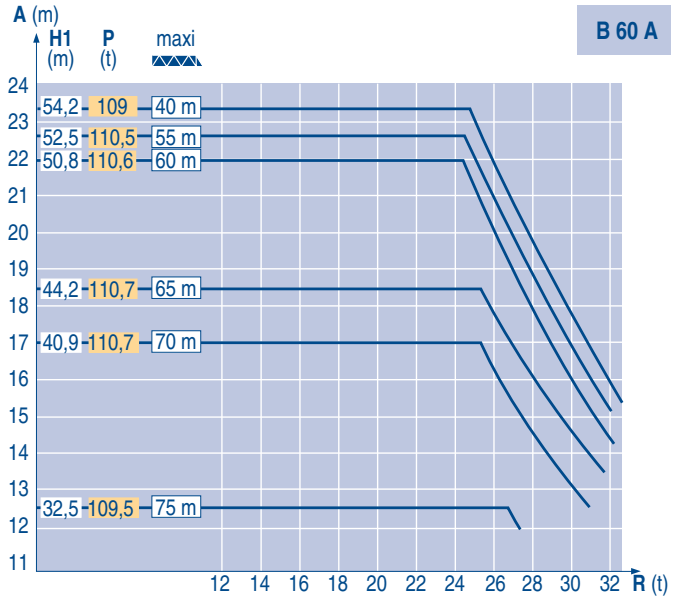
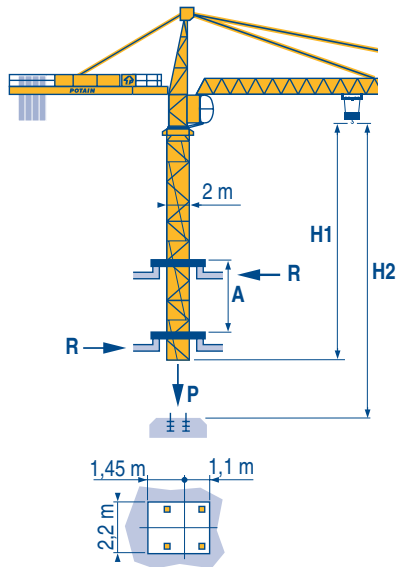

TOPKIT
 MD 365 B L16

POTAIN

F	D	GB	E	I	P
● Réactions en service ■ Réactions hors service	● Reaktionskräfte in Betrieb ■ Reaktionskräfte außer Betrieb	● Reactions in service ■ Reactions out of service	● Reacciones en servicio ■ Reacciones fuera de servicio	● Reazioni in servizio ■ Reazioni fuori servizio	● Reações em serviço ■ Reações fora de serviço
A vide sans lest (ni train de transport) avec flèche et hauteur maximum.	Ohne Last, Ballast (und Transportachse), mit Maximalausleger und Maximalhöhe.	Without load, ballast (or transport axles), with maximum jib and maximum height.	Sin carga, sin lastre, (ni tren de transporte), flecha y altura máxima.	A vuoto, senza zavorra (ne assali di trasporto) con braccio massimo e altezza massima.	Sem carga (nem trem de transporte)- sem lastro com lança e altura máximas.

Courbes de charges

Lastkurven

Load diagrams

Curvas de cargas

Curve di carico

Curva de cargas

LW 1

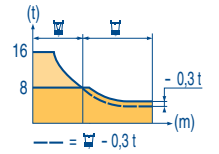
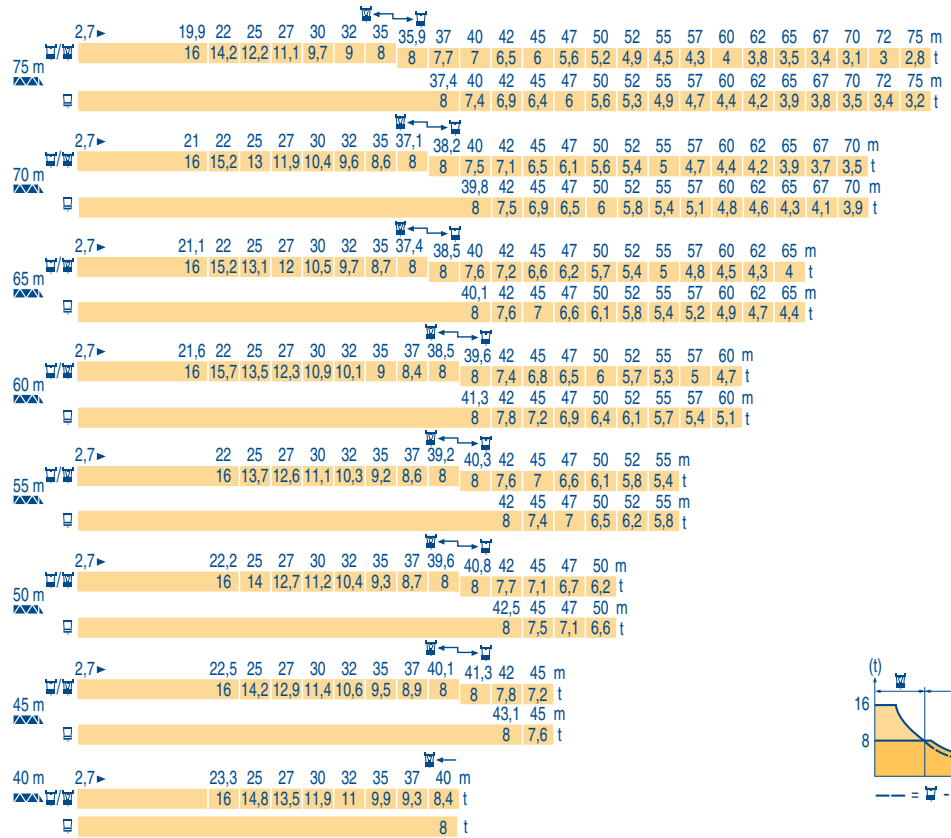

Lest de contre-flèche

Gegenauslegerballast

Counter-jib ballast

Lastre de contra flecha

Contrappeso

Lastros da contra lança

LW 2

Crane Model	Jib Length (m)	75 LVF			100 LVF			150 LCC		
		4200 kg	700 kg	▲ (kg)	4200 kg	700 kg	▲ (kg)	4200 kg	700 kg	▲ (kg)
75 m	24,2 m	5	4	23 800	5	3	23 100	5	2	22 400
70 m	24,2 m	5	-	21 000	4	5	20 300	4	3	18 900
65 m	24,2 m	4	3	18 900	4	3	18 900	4	1	17 500
60 m	24,2 m	4	-	16 800	3	5	16 100	3	3	14 700
55 m	24,2 m	3	3	14 700	3	3	14 700	3	2	14 000
50 m (B60A)	24,2 m	3	2	14 000	3	1	13 700	3	-	12 600
50 m	18,2 m	5	5	24 500	5	4	23 800	5	3	23 100
45 m	18,2 m	5	-	21 000	4	5	20 300	4	4	19 600
40 m	18,2 m	4	2	18 200	4	1	17 500	4	-	16 800

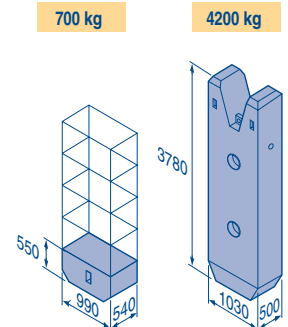

Lest de base - Grundballast

Base ballast - Lastre de base

Zavorra di base - Lastros da base

LW 1

Crane Model	V 60 A	H (m)	69,2	65,9	60,9	55,9	50,9	45,9	40,9	35,9	30,9	25,9	20,9	15,9
2 m	▲	(t)	108	108	108	108	108	108	96	96	96	84	84	84

Ancrages

Verankerungen

Anchorage

Anclaje

Ancoraggio

Ancoragem

LW 1

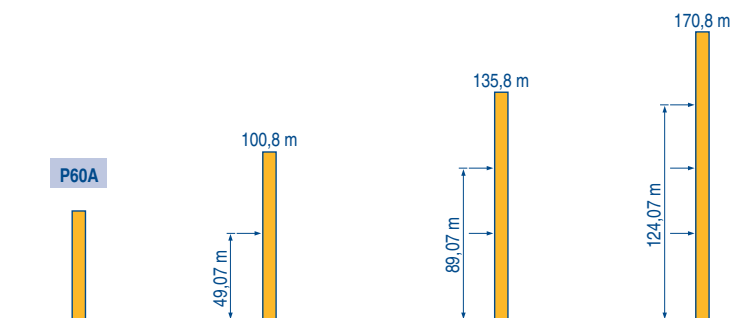

TOPKIT



MD 365 B L16





	F	D	GB	E	I	P
A	Distance entre cadres	Abstand zwischen den Rahmen	Distance between collars	Distancia entra marcos	Distanza fra i telai	Distância entre quadros
H1	Hauteur grue	Kranhöhe	Crane height	Altura grúa	Altezza gru	Altura da grua
P	Poids de la grue(en service)	Krangelicht (in Betrieb)	Crane weight (in service)	Peso de la grúa (en servicio)	Peso della gru (in servizio)	Peso da grua (em serviço)
R	Réaction horizontale	Horizontalkräfte	Horizontal reaction	Reaccion horizontal	Reazione orizzontale	Reacção horizontal
	Voit télescopage sur dalles	Siehe Kletterkrane im Gebäude	See climbing crane	Veja grua trepadora	Consultare gru in cavedio	Ver telescopagem sobre lages

Mécanismes
Antriebe
Mechanisms
Mecanismos
Meccanismi
Mecanismos

LYW 3

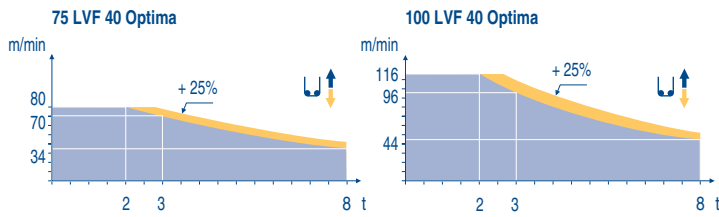
		↕ ↑					↕ ↕					ch - PS hp	kW												
↕	75 LVF40 Optima	m/min	0	→	34	→	44	→	70	→	80	0	→	17	→	22	→	35	→	40	75	55	553 m		
		t			8			6		3		2			16			12		6		4			
	m/min	0	→	44	→	56	→	96	→	116	0	→	22	→	28	→	48	→	58	100	75	1009 m			
	100 LVF40 Optima	t			8			6		3		2			16			12		6		4			
	150 LCC 40	m/min	68	→	82	→	102	→	136	→	162	34	→	41	→	51	→	68	→	81	150	110	596 m		
		t	8		6		4		2		1	16		12		8		4		2					
↔	6 DVF 6	m/min	0 → 42 (16 t) 0 → 84 (8 t) 0 → 100 (4 t)										5,5	4											
↻	RVF 182 OPTIMA	tr/min U/min rpm	0 → 0,7										2 x 12	2 x 9											
↻	V 60 A RT 544 A1 2V R ≥ 13 m	m/min	13,5 - 27										4 x 7	4 x 5,2											
CEI 38 		IEC 38		kVA																					
400 V (+6% -10%) 50 Hz				75 LVF : 100 kVA 100 LVF : 125 kVA 150 LCC : 175 kVA					2000/14																



	F	D	GB	E	I	P
	Levage	Heben	Hoisting	Elevación	Sollevaramento	Elevação
	Distribution	Katzfahren	Trolleying	Distribución	Ditribuzione	Distribuição
	Orientation	Schwenken	Slewing	Orientación	Rotazione	Rotação
	Translation	Kranfahren	Travelling	Traslación	Traslazione	Translação
	Conforme aux directives CEE sur le niveau acoustique	Gemäss EWG-Richtlinien für den Schall-Leistungspegel	In compliance with the EEC Instructions on noise level	Conforme con las directivas CEE sobre el nivel acústico	Conforme alle direttive CEE sul livello acustico	Conforme as directivas CEE sobre o nível acústico

 Document commercial non contractuel. Pour toute information technique se référer à la notice correspondante

Unverbindliches Vertriebsdokument. Für technische Informationen, siehe die entsprechenden Anweisungen.

This commercial document is not legally binding. For any technical information, please refer to the corresponding instructions.

Documento comercial no contractual. Para cualquier información técnica, ver la noticia correspondiente.

Documento commerciale non vincolante, per tutte le informazioni tecniche fare riferimento al catalogo istruzioni

Documento comercial não contratual. Para qualquer informação técnica complementar consultar as respectivas instruções

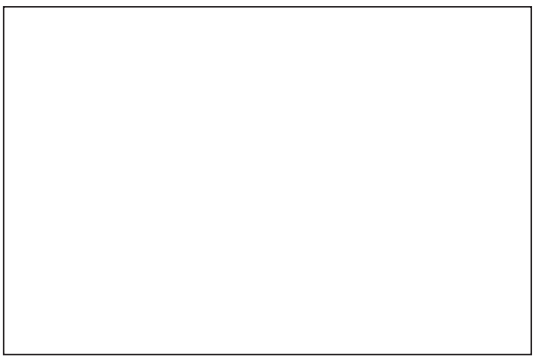







Manitowoc Crane Group

18, rue de Charbonnières - B.P.173
69132 ECULLY Cedex - France

Tél. : (33) 4 72 18 20 20
 Fax. : (33) 4 72 18 20 00
www.manitowoccrane.com www.potain.com





Americas
Tel: +1 920 683 6322
Tel: +1 717 597 8121

Europe - Middle East - Africa
Tel: +(33) 4 72 81 50 00
Tel: +(44) 191 565 6281

Asia - Pacific
Tel: +(65) 6861 7133
Fax: +(65) 6862 4142

www.manitowoccrane.com

TOPKIT MD 365 B L16
 Réf. 2003 48 LYW 3

Copyright.Reproduction interdite © POTAIN 2003

Réalisation Sedoc